

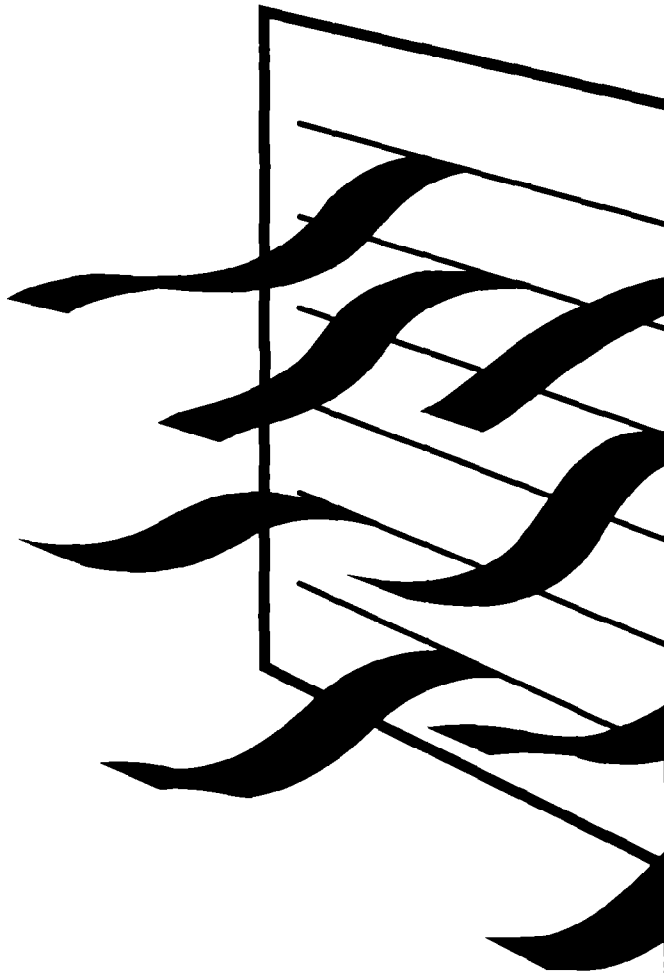

HOW TO MAKE A HOME RUN.™

Installation & User's Guide



A Note To You	2
Important Safety Instructions	3
Electrical requirements	4
Receptacle wiring	5
Parts and Features	6
Installation Instructions	7
Before you begin	7
Tools/supplies needed	8
Parts supplied for installation	8
Installation tips	9
Window installation	9
Through-the-wall installation	13
Operating Instructions	17
Starting your air conditioner	17
Changing air direction	17
Cleaning Instructions	18
Cleaning the air filter	18
Cleaning the front panel	19
Maintenance Instructions	20
Annual maintenance	20
Repairing paint damage	22
Saving energy	22
Troubleshooting	23
Requesting Assistance or Service	24
Warranty	28

AIR CONDITIONERS

MODELS: ACM152XE0, ACM184XE0, ACM244XE0

A Note to You

Thank you for buying a WHIRLPOOL® appliance.

Because your life is getting busier and more complicated, WHIRLPOOL Air Conditioners are easy to use, save time, and help you manage your home better. To ensure you enjoy years of trouble-free operation, we developed this Use and Care Guide. It contains valuable information about how to operate and maintain your appliance properly and safely. Please read it carefully. Also, please complete and mail the Ownership Registration Card provided with your appliance. This card helps us notify you about any new information on your appliance.

Please record your model's information.

Whenever you call to request service on your appliance, you need to know your complete model number and serial number. You can find this information on the model and serial number label.

Please also record the purchase date of your appliance and your dealer's name, address, and telephone number.

Model Number _____

Serial Number _____

Purchase Date _____

Dealer Name _____

Dealer Address _____

Dealer Phone _____

Keep this book and the sales slip together in a safe place for future reference.

**Our Consumer Assistance
Center number is toll-free
24-hours a day.**

1-800-253-1301

Important Safety Instructions

Your safety is important to us.

This guide contains safety symbols and statements. Please pay special attention to the symbols and follow any instructions given. Here is a brief explanation of the use of the symbol.

WARNING

This symbol alerts you to such dangers as fire, electrical shock, burns, cuts, and personal injury.

WARNING

To reduce the risk of fire, electrical shock, or personal injury when using your air conditioner, follow these basic precautions:

- Read all instructions before using your air conditioner.
- Complete the Installation Instructions as described in this manual.
- Never allow children to operate or play with the air conditioner.
- DO NOT operate the air conditioner with the front panel removed.
- Disconnect power supply cord from receptacle before servicing. Refer to model and serial number label for BTU capacity, amperage, voltage, and refrigerant charge specifications.

- Never clean air conditioner parts with flammable fluids. The fumes can create a fire hazard or explosion.

• FOR YOUR SAFETY •

DO NOT STORE OR USE GASOLINE OR OTHER FLAMMABLE VAPORS AND LIQUIDS IN THE VICINITY OF THIS OR ANY OTHER APPLIANCE. THE FUMES CAN CREATE A FIRE HAZARD OR EXPLOSION.

– SAVE THESE INSTRUCTIONS –

It is your responsibility to be sure your air conditioner:

- is installed in a window or wall that will support the weight of the unit.
- is installed and secured according to the Installation Instructions described in this manual.
- is connected only to the proper kind of outlet, with the correct electrical supply and grounding. (See "Electrical requirements" on page 4.)
- is the proper size for the area you want to cool.

- is used only for the job it is designed to do.
- is not used by children or anyone unable to operate it properly.
- is properly maintained.

Also, remove the Energy Label and Buy Guide. Use a damp cloth to take off any glue residue. Do not use sharp instruments, flammable fluids, or abrasive cleaner. These can damage the material.

IMPORTANT SAFETY INSTRUCTIONS

Electrical requirements

⚠ WARNING



Electrical Shock Hazard

Plug air conditioner into grounded three prong outlet.

Do not remove ground prong.

Do not use an adapter.

Do not fuse neutral or grounding circuit.

Do not use air conditioner with front panel removed.

Failure to follow these instructions can result in death, electrical shock, or serious injury.

⚠ WARNING



Fire Hazard

Do not use an extension cord.

Doing so can result in death, fire, or electrical shock.

Grounding method

For your personal safety, this appliance must be grounded. This air conditioner is equipped with a power supply cord containing a 3-prong grounding plug. To minimize possible shock hazard, the cord must be plugged into a mating 3-prong grounding-type wall receptacle, grounded in accordance with all local codes and ordinances. If a mating wall receptacle is not available, it is the responsibility of the consumer to have a proper wall receptacle installed by a qualified electrician.

Electrical ground is required on this appliance.

DO NOT, UNDER ANY CIRCUMSTANCES, REMOVE THE POWER SUPPLY CORD GROUNDING PRONG.

OBSERVE ALL LOCAL CODES AND ORDINANCES.

NOTE: If codes permit, and a separate grounding wire is used, it is recommended that a qualified electrician determine that the grounding path is adequate. Use a time-delay fuse or time-delay circuit breaker. It is required that a separate circuit, serving only this air conditioner, be provided. See the chart on page 5 for electrical plug variations. Choose the plug that matches your unit's plug. Then, use the chart to find the voltage and ampere requirements for your air conditioner, and the gauge of copper wire required for the receptacle wiring.

IMPORTANT SAFETY INSTRUCTIONS

Receptacle wiring

See the chart below for minimum gauge for receptacle wiring. Use copper wire only. It is the responsibility of the consumer to provide proper and adequate receptacle wiring, installed by a qualified electrician. Observe the National Electrical Code and all local governing codes and ordinances.

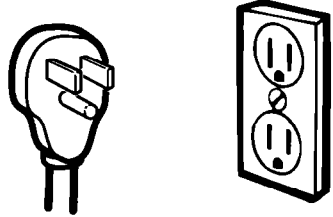
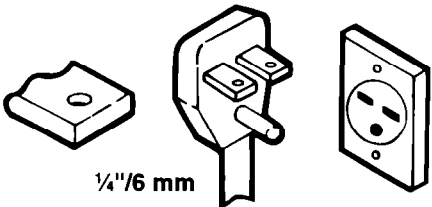
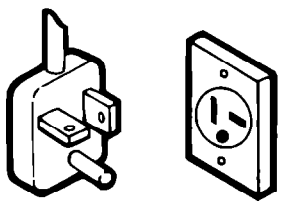
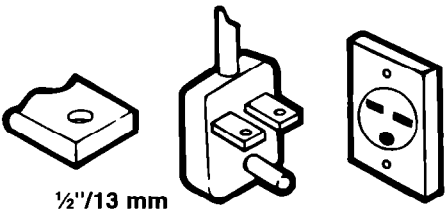
REQUIREMENTS	COPPER WIRE	PLUG
<ul style="list-style-type: none"> • 115 volt (103.5 min.-126.5 max.) • 0-12 amperes • 15 amp time-delay fuse or circuit breaker 	14 gauge	
<ul style="list-style-type: none"> • 230 volt (207 min.-253 max.) or • 230/208 volt (197.6 min.-253 max.) • 0-12 amperes • 15 amp time-delay fuse or circuit breaker 	14 gauge	 <p style="text-align: center;">1/4"/6 mm</p>
<ul style="list-style-type: none"> • 230 volt (207 min.-253 max.) or • 230/208 volt (197.6 min.-253 max.) • 0-16 amperes • 20 amp time-delay fuse or circuit breaker 	12 gauge	
<ul style="list-style-type: none"> • 230 volt (207 min.-253 max.) or • 230/208 volt (197.6 min.-253 max.) • 0-24 amperes • 30 amp time-delay fuse or circuit breaker 	10 gauge	 <p style="text-align: center;">1/2"/13 mm</p>

Parts and Features

This section contains captioned illustrations of your appliance. Use them to become familiar with where all parts and features are located and what they look like. To help you find information on specific parts or features quickly, page references are included.

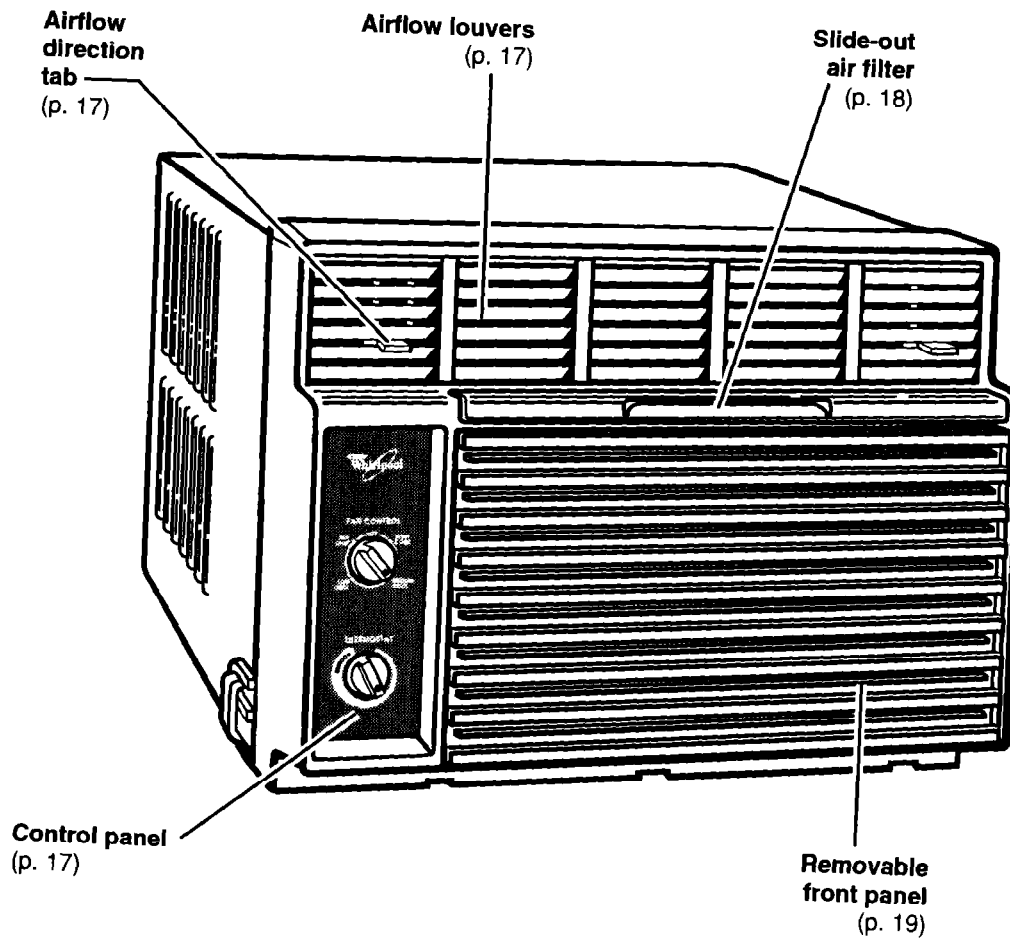

Installation Instructions

Proper installation of your air conditioner is important for proper operation and best cooling results. To avoid any installation problems and to ensure trouble-free performance of your new air conditioner, please read these Installation Instructions, as well as the operating instructions and electrical requirements **before** installing your unit.

IMPORTANT: Observe all governing codes and ordinances.

⚠ WARNING

Excessive Weight Hazard

Use two or more people to move and install air conditioner.

Failure to do so can result in back or other injury.

Before you begin

Check the window/wall location where the air conditioner will be installed for the following:

- The opening/window is large enough.
Remember to add twice the thickness of the wood to be used to build the frame.
- The wall/window is sturdy enough to support the weight of the air conditioner – 145 to 200 pounds (65 to 90 kg).
- An electrical supply is within reach of the power supply cord.
- Air will move freely into rooms to be cooled.

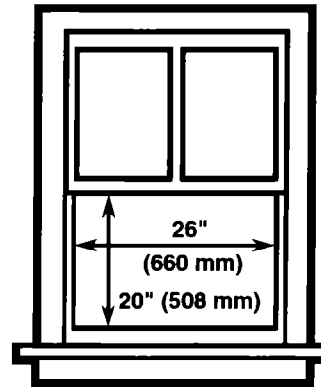

Window opening measurements

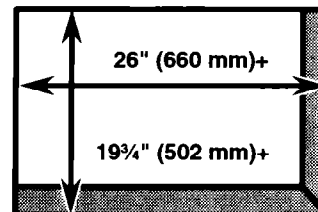

Wall opening measurements

INSTALLATION INSTRUCTIONS

Tools/supplies needed

1. Flat-blade screwdriver
2. Tape measure
3. Utility knife
4. Socket wrench with $\frac{7}{16}$ " (11 mm) and $\frac{1}{4}$ " (6 mm) sockets
OR
 $\frac{1}{4}$ " (6 mm) nut driver
5. Electric drill
6. $\frac{3}{32}$ " (2 mm) or smaller drill bit
7. Carpenter's level

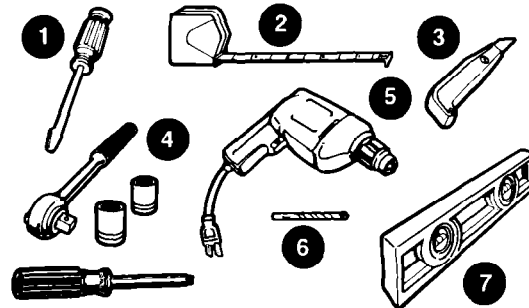

For through-the-wall installation:

8. Wood preservative
9. #10 x 1" (25 mm) screws [10]

Parts supplied for installation

- A. $\frac{3}{8}$ " (10 mm) seal strips [5]
- B. Side mounting brackets [2]
- C. #8 x $\frac{3}{8}$ " (10 mm) hex-head sheet-metal screws [4]
- D. Filler board [1]
- E. #8 x $\frac{1}{2}$ " (12.5 mm) hex-head metal screws [4]
- F. Foam seal [1]
- G. Foam blocks [4]
- H. #10 x $\frac{3}{4}$ " (19 mm) round-head wood screws [3]
- I. $2\frac{1}{2}$ " (63.5 mm) seal strip [1]
- J. Vertical supports [2]
- K. Angled supports [2]
- L. $\frac{3}{4}$ " (19 mm) round-head bolts [6]
- M. Flat washers [6]
- N. Lock washers [6]
- O. Nuts [6]
- P. Wall rail [1]
- Q. Foam window rail seal [1]
- R. Window lock bracket [1]
- S. Plastic drain cup [1]
- T. Gum-type sealer [1]

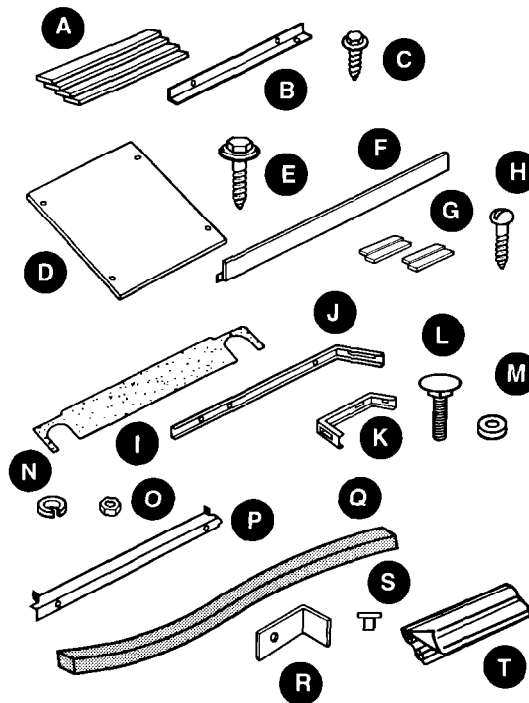

Installation parts are supplied for double-hung windows up to 40" (1,016 mm) wide. Installation up to 54" (1,372 mm) can be made with a special "Wide-window kit" from your dealer or authorized service center.

Installation tips

- Handle the air conditioner with care. Watch out for the sharp metal fins on the front and rear coils.
- Be sure your air conditioner does not fall out of the opening during installation.
- Do not install the air conditioner in an area where the front panel will be exposed to heat sources that will raise the panel surface temperature above 120°F (50°C).

Window installation

1. **Remove the ground wire and screw from the front of the unit base.** Save grounding screw for reattachment in Step 23.
2. **Attach 3/8" (10 mm) seal strip (A) to bottom of both side mounting brackets (sides with screw holes).** Cut strips to length and save extra for use later.
3. **Attach side mounting brackets (B) to cabinet.** Place side mounting brackets on cabinet so bent edge is toward front of cabinet. Attach each with 2 hex-head metal screws (C).
4. **Slide unit out of cabinet.** Grasp handle and slide unit straight out of cabinet. Place unit on cardboard to protect your floor.
5. **Place empty cabinet in window.** Lower window sash to hold cabinet in place. Make sure the cabinet is centered in the window opening.
6. **Measure width of window channel and subtract thickness of filler board.** Cut foam blocks 1/4" (6 mm) wider than this measurement. The blocks will be used later in Step 15.

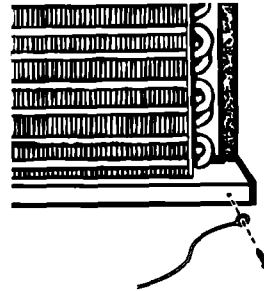

7. **Determine proper size for filler board (D).** Measure the distance from the right edge of the cabinet to the inside of the right window channel. Then add 1/8" (3 mm) to that measurement. Repeat for left side.

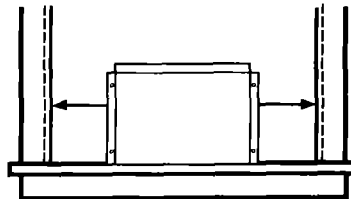
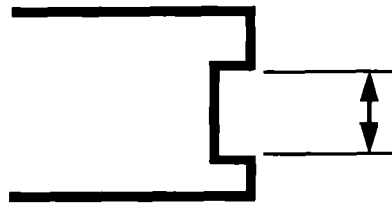

continued on next page

INSTALLATION INSTRUCTIONS

8. **Cut filler board (D) to size with utility knife.** Cut in from the outside edges. The outside edges should have screw holes in them.

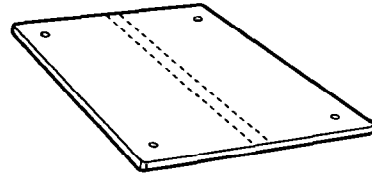

9. **Apply 3/8" (10 mm) seal strip (left over from Step 2) to the filler boards.** Apply seal strips to the bottom front and outside front edges of the filler boards.

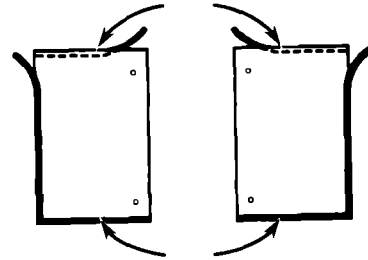

10. **Attach left filler board to cabinet.** Pull cabinet part way out of the window. Then attach the left filler board to the front of the left side mounting bracket. Use 1/2" (12.5 mm) hex-head metal screws (E).

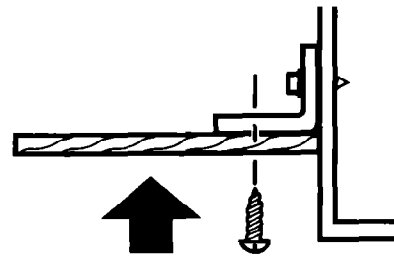

11. **Position left filler board in window channel.** Place cabinet back into window. Make sure left filler board sits tightly against the window channel.

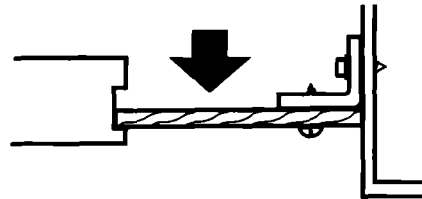

12. **Attach right filler board to cabinet.** Insert right filler board into right window channel. Push filler board against right side mounting bracket and attach it with 1/2" (12.5 mm) hex-head metal screws (E).

13. **Apply foam seal (F).** Measure from right inside edge of window frame to left inside edge. Then cut the foam seal, with square ends, to fit. Hold the cabinet to prevent it from falling. Raise window sash and place adhesive side of foam seal along underside of window.

14. **Make sure filler boards are as far forward (toward inside room) in window channels as possible.**

15. **Insert foam blocks (G) into window channels – behind filler boards about 3-4 inches from the top and bottom edges.** The blocks keep the filler board tight to the window channel.



INSTALLATION INSTRUCTIONS

16. Fasten cabinet to window sill. Lower window sash firmly onto cabinet. Place a carpenter's level inside the cabinet and make sure cabinet is level side-to-side. Then drill starter holes into the cabinet base and the window sill. Use round-head wood screws (**H**) to fasten cabinet to window sill, but do not tighten the screws.

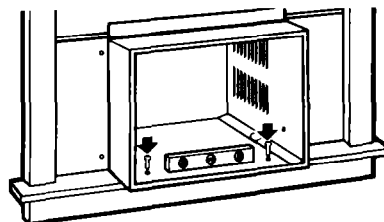

17. Make sure cabinet has proper outward slope. Place carpenter's level in the right side of the cabinet. There should be a ½ bubble tilt (¼" [6 mm] per foot [30.5 cm]) toward the outside. Repeat for left side of cabinet. The tilt to the outside is needed for proper drainage.

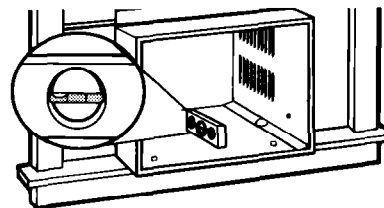

18. Attach 2½" (63.5 mm) seal strip (I) to inside of cabinet. Make sure the seal strip is flush with the front edge of the cabinet. This seal strip provides a seal between the air conditioner base and the cabinet.

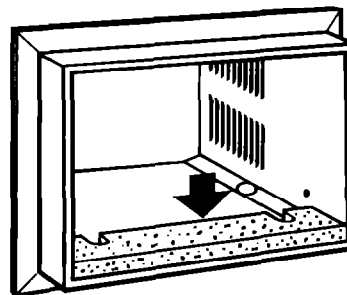

19. Assemble the outside support. Attach the vertical supports (**J**) to the angled supports (**K**). Use the round-head bolts (**L**), flat washers (**M**), lock washers (**N**) and the nuts (**O**) for attachments. Then attach these supports to the bottom of the cabinet, but DO NOT tighten the bolts at this time.

Attach the wall rail (**P**) to the bottom of the supports and slide the support assembly toward the house until the wall rail presses firmly against the wall.

Check that you have the ½ bubble tilt to the outside. This is needed for proper drainage.

Now tighten all bolts. Tighten angled support bolts last so wall rail fits tightly against the house.

NOTE: If your house is constructed of materials that could be damaged by the wall rail, fasten a board or other protective material to the wall rail so that it is between the wall rail and the house.

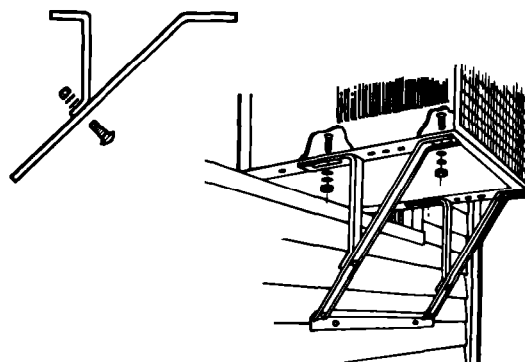

continued on next page

INSTALLATION INSTRUCTIONS

20. Install foam window rail seal (Q), the window lock bracket (R), and the plastic drain cup (S).

- Insert foam rail seal between the top of the lower window sash and the glass of the upper window.
- Place window lock bracket on top of lower window sash and against upper window sash. Drill a starter hole through the lock bracket into the window sash. Attach window lock bracket.
- Insert plastic drain cup into hole in right side of cabinet base.

NOTE: Install window lock bracket to prevent air conditioner from falling out of the window.

21. Seal any small openings around window with gum-type sealer (T).

22. Insert air conditioner into cabinet.

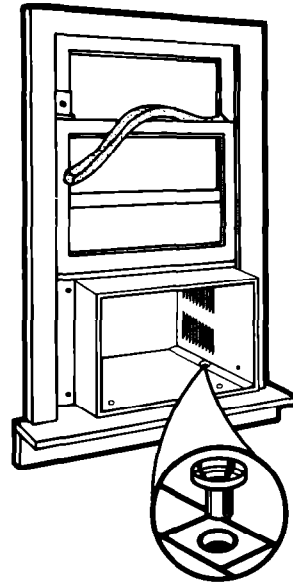

⚠ WARNING



Electrical Shock Hazard

Connect green ground wire to cabinet.

Failure to do so can result in death or electrical shock.

23. Reattach ground wire with grounding screw. Put excess grounded wire between the coils and the cabinet.

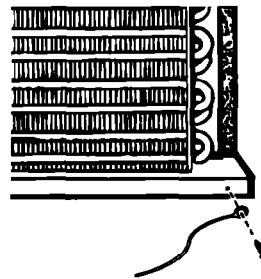

INSTALLATION INSTRUCTIONS

- 24. Attach the front panel.** Remove the 2 front panel screws from unit base. Replace front panel by pushing it straight on and then lowering it slightly to lock it in place. Attach bottom front of panel by reinserting the 2 front panel screws.

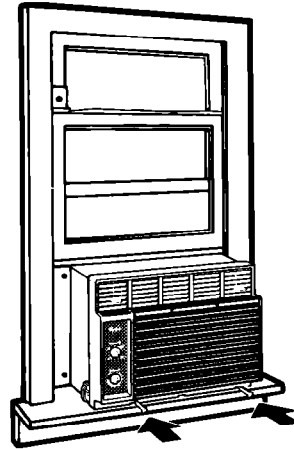

Through-the-wall installation

It is the consumer's responsibility and obligation to have this product installed by a qualified technician who is familiar with through-the-wall room air conditioner installations.

- 1. Cut an opening through the wall.** Remove any insulation and keep for Step 8.
- 2. Measure depth of wall opening and construct finish frame.** Use 1" (25 mm) or heavier lumber for wood frame construction. When using a wood, metal, or plastic molding, the finish frame should line up with the inside wall. If a plastered wall is to be flush with the cabinet, and no molding is used, the finish frame must be set 1/2" (13 mm) back from the finished plaster surface. **See illustrations at right** for frame construction and brick veneer construction information.

Finish frame measurements include:

- A** – Wall opening width
- B** – Wall opening height
- C** – Depends on wall thickness and type of molding

NOTE: Apply wood preservative to the surface exposed to the outside.

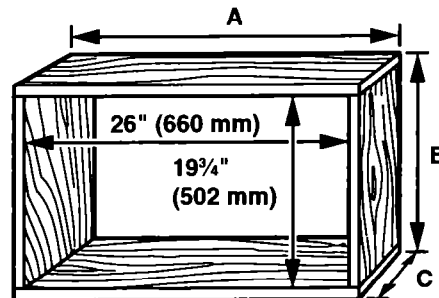
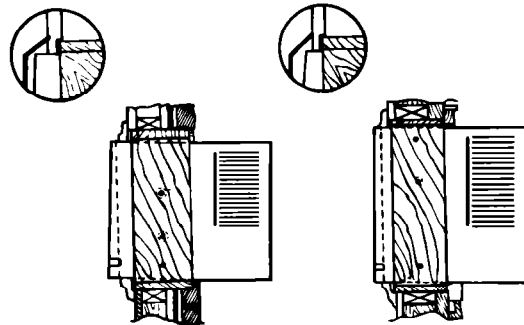

continued on next page

INSTALLATION INSTRUCTIONS

3. Insert finish frame into wall opening.

Square and level the frame. Nail frame securely to the wall studs.

4. Remove the ground wire and screw from the front of the unit base. Save grounding screw for reattachment in Step 13.

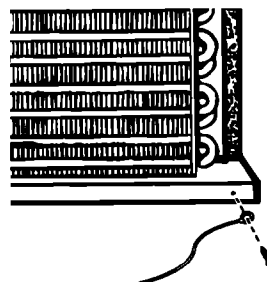

5. Slide unit out of cabinet. Grasp handle and slide unit straight out of cabinet.

Place unit on cardboard to protect your floor covering.

6. Insert cabinet into the wall opening.

The top of the cabinet should extend $\frac{1}{2}$ " (13 mm) into the room. If there is trim, the cabinet should extend $\frac{1}{2}$ " (13 mm) past the trim.

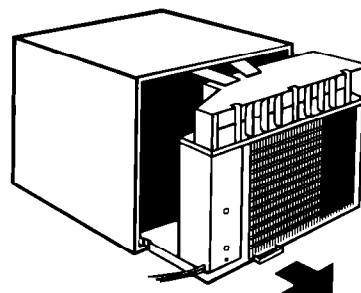

7. Check the outward slope of the cabinet. Place a carpenter's level inside the cabinet on the right side. There should be $\frac{1}{2}$ bubble ($\frac{1}{4}$ " [6 mm] per foot [30.5 cm]) slope toward the outside. Also check the left side.

NOTE: Make sure the air conditioner cabinet has the proper outward slope so condensate water runs to the outside or damage could result to the floor or wall.

8. Seal opening between cabinet and finish frame. Use the insulation removed in Step 1.

9. Attach cabinet to finish frame. Use #10 x 1" (25 mm) wood screws (not supplied) to attach cabinet to the frame.

IMPORTANT: Do not overtighten screws or the cabinet will distort and provide a poor air seal between the cabinet and the air conditioner.

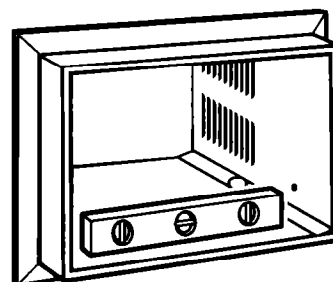

INSTALLATION INSTRUCTIONS

10. Place the 2½" (63.5 mm) seal strip (I) inside the cabinet. Make sure the seal is flush with the cabinet front edge.

NOTE: This seal strip fits between the air conditioner base and the cabinet.

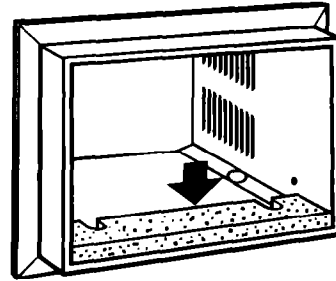

11. Insert drain cup (S). Place drain cup through hole in cabinet rail.
12. Insert air conditioner into cabinet.

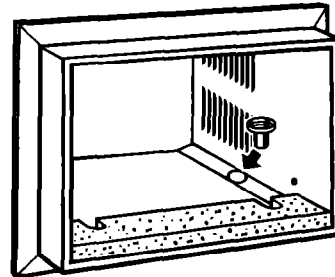

⚠ WARNING



Electrical Shock Hazard

Connect green ground wire to cabinet.

Failure to do so can result in death or electrical shock.

13. Reattach ground wire with grounding screw. Put excess grounded wire between the coils and the cabinet.

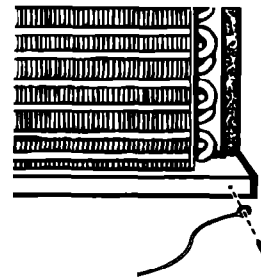

continued on next page

INSTALLATION INSTRUCTIONS

14. **Attach the front panel.** Remove the 2 front panel screws from unit base. Replace front panel by pushing it straight on and then lowering it slightly to lock it in place. Attach bottom front of panel by reinserting the 2 front panel screws.
15. **Caulk all outside wall openings around the installation and cabinet.**
16. **Install decorative molding.** If desired, install molding around room side of cabinet.

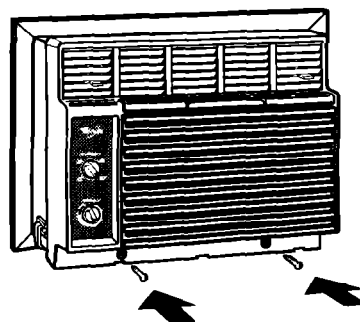

Operating Instructions

Starting your air conditioner

1. Plug air conditioner into a grounded 3-prong outlet.
2. Set Fan Control to desired setting.
(All settings below not on all models.)
HIGH COOL for maximum cooling
MEDIUM COOL for normal cooling
LOW COOL for sleeping comfort
FAN ONLY for circulating air without cooling
3. Set Thermostat to a mid-setting. You can adjust the air conditioner's performance by resetting the Thermostat to a higher or lower setting. You will need to experiment to find the setting(s) which work best for you.

NOTE: If you turn your air conditioner off or if the compressor turns off when you lower the Thermostat, wait at least 3 minutes before turning unit back on. Failure to do so could blow a household fuse or trip a circuit breaker.

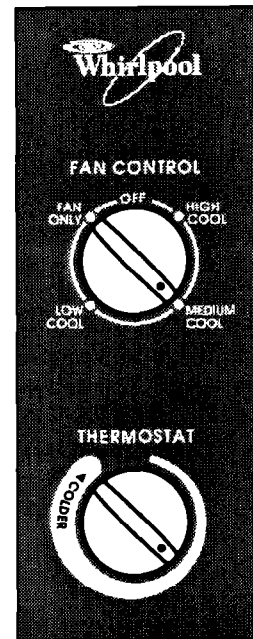

Changing air direction

The louvers in the top section of the air conditioner front panel control the direction of the cooled air. Move the tab in the direction you want the air to go – up, down, or straight ahead.

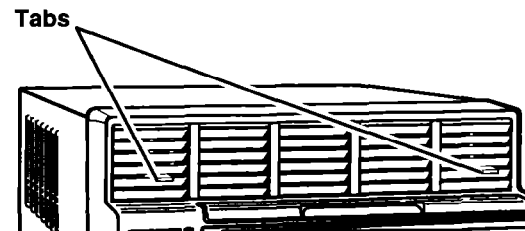

Cleaning Instructions

Proper use and care of your air conditioner will help ensure longer life of the unit and lower operating costs. Follow these cleaning instructions.

Cleaning the air filter

The air filter is cleanable. A clean filter helps remove dust, lint, and other particles from the air. Check every 2 weeks to see if the filter needs to be cleaned.

1. Remove air filter from front panel.
 - Grasp filter handle.
 - Slide filter straight up and out of the front panel.
2. Clean filter using a vacuum cleaner.
OR
If very dirty, wash filter with warm water and a mild detergent. Air dry thoroughly before replacing.
3. Replace air filter.
 - Guide bottom of filter into filter slot in front panel.
 - Slide filter straight down into front panel.

NOTE: The front panel does not have to be removed to clean the filter.

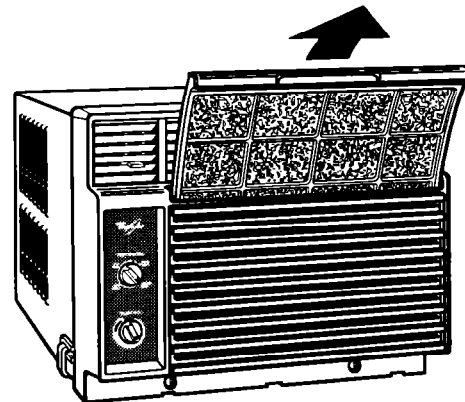

Cleaning the front panel

⚠ WARNING



Explosion Hazard

Unplug power cord from outlet before cleaning air conditioner.

Use only nonflammable cleaners.

Failure to follow these instructions can result in death, explosion, fire, or electrical shock.

1. Unplug the power cord.
2. Remove the front panel from the unit.
 - Remove the 2 screws from the bottom edge of the front panel.
 - Lift front panel slightly and then pull it toward you.
3. Remove the slide-out air filter from the front panel. Clean it separately. See "Cleaning the air filter."
4. Clean front panel with warm water and a mild soap or detergent. Use a soft cloth. Rinse and dry.
5. Wipe the control panel clean with a soft, dry cloth.
6. Replace the front panel.
 - Push it straight onto the cabinet. Then lower it slightly to lock it in place.
 - Replace the 2 screws in the base of the front panel.
7. Plug in the power cord.

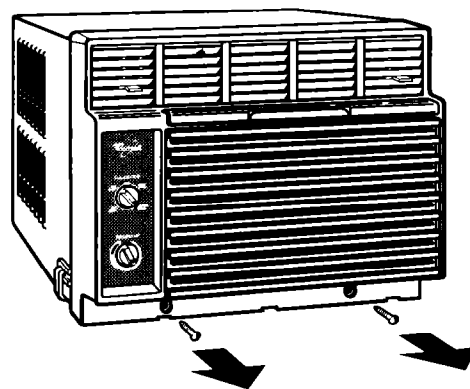

Maintenance Instructions

Annual maintenance

Your air conditioner needs annual maintenance to ensure steady, top performance throughout the year.

Call the service company recommended by your dealer to:

- Inspect and clean the coils and condensate water passages.
- Check fan and fan motor.

The compressor and fan motor are sealed and need no oiling. Expense of the annual inspection is the consumer's responsibility.

NOTE: If you are familiar with electrical appliances, you can do the cleaning and maintenance yourself. If you choose to do so, follow these steps:

! WARNING

Electrical Shock Hazard Unplug power cord from outlet before servicing. Be sure no liquid gets into the motor, electrical control box, or compressor terminals. Failure to follow these instructions can result in death, electrical shock, or serious injury.

! WARNING
Excessive Weight Hazard Use two or more people to move and install air conditioner. Failure to do so can result in back or other injury.

MAINTENANCE INSTRUCTIONS

NOTE: Do not lift, push, or pull on any white beaded foam (expanded polystyrene) parts.

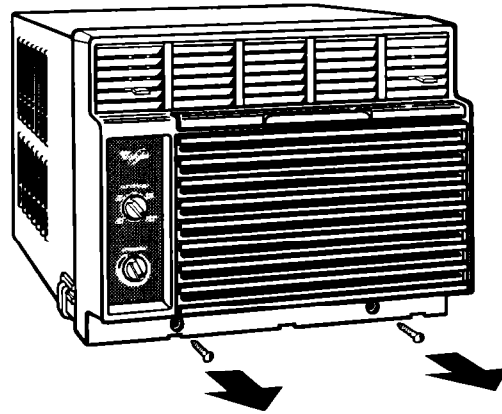
1. Unplug power cord.
2. Remove the front panel from the unit.
 - Remove the 2 screws at the base of the front panel.
 - Lift front panel slightly and then pull it toward you.



3. Slide unit out of cabinet using the wire handle. Watch out for the sharp metal fins on the front and rear coils.

NOTE: Water may have collected inside the air conditioner cabinet, and it could spill on the floor. Handle unit carefully.

4. Wrap the motor, connector plug, electrical control box, and compressor terminal box in plastic film. Make sure no liquid gets inside any of these parts. It could damage the insulation and cause serious mechanical problems.

NOTE: Water from rainfall or normal operation does not harm these components.

5. Carefully clean and hose out the base, condenser coils, and condensate pans. Clean at least once a year, or more often if the condenser coil and pan collect dirt, sand, leaves, insects, or algae. Also clean if you detect an odor coming from the air conditioner.
6. Remove the plastic film from the motor and electrical parts.
7. Replace air conditioner in the cabinet.
8. Replace the front panel.
 - Push front panel straight onto cabinet. Then lower it slightly to lock it in place.
 - Replace the 2 screws in the base of the front panel.
9. Plug in power cord.

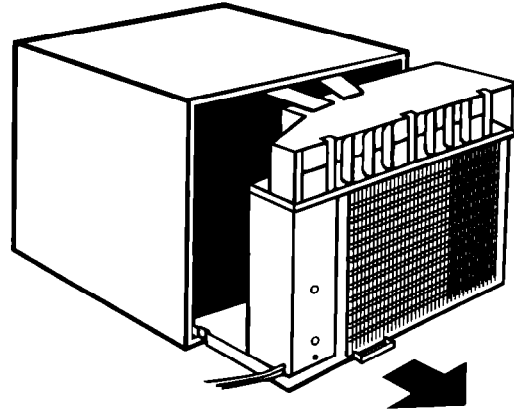

NOTE: It is a good idea to wait 24 hours before starting the unit again. This allows time for all areas to dry thoroughly.

Repairing paint damage

Check once or twice a year. This is very important, especially in areas near oceans or where rust is a problem. If needed, touch up with a good grade enamel paint.

Saving energy

You can help save energy by doing the following.

- Improve your home's insulation. Seal doors and windows. Close fireplace flues.
- Close blinds or drapes on the sunny side of the house. Add awnings.
- Check air filter often to make sure it is clean.
- Do not block airflow with drapes or furniture.
- Ventilate your attic. High temperatures in the attic add to the cooling load of your air conditioner.
- Try not to use heat-producing appliances during the hottest part of the day.
- Turn lights and appliances off when they are not needed.
- Keep heat registers and cool-air returns closed.
- Use exhaust/venting fans while cooling, bathing, and doing laundry.
- Turn your Fan Control to Off if you will be away for a long time. The air conditioner will not come on again until the Fan Control is set to a Cool setting.

Troubleshooting

Before calling for service:

Performance problems often result from little things you can fix yourself without tools of any kind.

PROBLEM	SOLUTION
Unit won't run	<ul style="list-style-type: none">• Make sure the power cord is plugged into a live circuit with the proper voltage.• Replace household fuse or reset the circuit breaker.• Make sure the Fan Control is not set to Off.• In case of local power failure, wait for power to be restored.
Unit blows household fuses or trips circuit breaker	<ul style="list-style-type: none">• Replace household fuse with a time-delay fuse of the correct capacity.• Do not use an extension cord with this or any other appliance.• Wait at least 3 minutes after turning unit off to turn it on again.
Unit turns off and on OR unit does not cool room	<ul style="list-style-type: none">• Clean the filter.• Clean the coils.• Use exhaust/venting fans to reduce room heat.• Set Fan Control to a higher fan speed.• Set Thermostat to a higher setting.

Normal operating sounds

When your air conditioner is operating normally, you will hear such sounds as:

- Droplets of water hitting the condenser, causing a "pinging" or "clicking" sound.
Water droplets help cool the condenser.
- Air movement from the fan – especially on High fan speed settings.
- Clicks from the cooling cycle.

Sounds also may be caused by house construction – such as vibration of the unit due to wall construction or unsteady window mounting area.

Requesting Assistance or Service

For service in the U.S.:

1. If you need assistance* ...

Call our toll-free Consumer Assistance Center telephone number from anywhere in the U.S.A.:

1-800-253-1301

and talk to one of our trained consultants. The consultant can instruct you in how to obtain satisfactory operation from your appliance or, if service is necessary, recommend a qualified service company in your area.

2. If you need service* ...

We have a nationwide network of authorized service companies. Our service technicians are trained to fulfill the product warranty and provide after-warranty service, anywhere in the United States. To locate an authorized Whirlpool service company in your area, call our Consumer Assistance Center telephone number (see Step 1) or look in your telephone directory Yellow Pages under:

APPLIANCES – HOUSEHOLD –
MAJOR – SERVICE & REPAIR

3. If you need FSP® replacement parts* ...

To locate replacement parts in your area, refer to Step 2 above or call our Consumer Assistance Center telephone number in Step 1.

4. If you are not satisfied with how the problem was solved* ...

- Contact the Major Appliance Consumer Action Program (MACAP). MACAP is a group of independent consumer experts that voices consumer views at the highest levels of the major appliance industry.
- Contact MACAP only when the dealer and authorized service company have failed to resolve your problem.

Major Appliance Consumer Action Program
20 North Wacker Drive
Chicago, IL 60606

- MACAP will, in turn, inform us of your action.
- * When requesting assistance or service, please provide: model number, serial number, date of purchase, and a complete description of the problem. This information will help us respond to your request properly.

NOTES

NOTES

NOTES

-

WHIRLPOOL® Warranty

LENGTH OF WARRANTY	WE WILL PAY FOR
FULL ONE-YEAR WARRANTY FROM DATE OF PURCHASE	FSP® replacement parts and repair labor to correct defects in materials or workmanship.
FULL FIVE-YEAR WARRANTY FROM DATE OF PURCHASE	FSP replacement parts and repair labor to correct defects in materials or workmanship in the sealed refrigeration system. These parts are: 1. Compressor 2. Evaporator 3. Condenser 4. Drier-Strainer 5. Connecting Tubing
WE WILL NOT PAY FOR	
<p>A. Service calls to:</p> <ol style="list-style-type: none"> 1. Correct the installation of your air conditioner. 2. Instruct you how to use your air conditioner. 3. Replace house fuses or correct house wiring. 4. Clean or replace the air filter. <p>B. Pickup and delivery. Your air conditioner is designed to be repaired in the home.</p> <p>C. Damage to your air conditioner caused by accident, misuse, fire, flood, acts of God, or use of products not approved by Whirlpool.</p> <p>D. The removal and reinstallation of your air conditioner if it is installed in an overhead or other inaccessible location or is not installed in accordance with published installation instructions.</p> <p>E. Repairs to parts or systems caused by unauthorized modifications made to the appliance.</p>	

6/94

Service under the full warranties must be provided by an authorized service company.

WHIRLPOOL CORPORATION SHALL NOT BE LIABLE FOR INCIDENTAL OR CONSEQUENTIAL DAMAGES. Some states do not allow the exclusion or limitation of incidental or consequential damages so this exclusion or limitation may not apply to you. This warranty gives you specific legal rights, and you may also have other rights which vary from state to state.

Outside the United States, a different warranty may apply. For details, please contact your authorized Whirlpool dealer.

If you need service, first see the "Troubleshooting" section of this book. After checking "Troubleshooting," additional help can be found by checking the "Requesting Assistance or Service" section or by calling our Consumer Assistance Center telephone number, **1-800-253-1301**, from anywhere in the U.S.A.